

Adjustable Spreader Lifting Beam 4000 lb / 2 ton - 120 in Max Spread

Key features

- Load Capacity: Safely lifts loads up to 4000 lbs (2 tons), ideal for heavy-duty lifting tasks.
- Adjustable Spread: Maximum spread of 120 inches allows for flexibility in accommodating various load sizes and configurations.
- Durable Construction: Built from high-quality materials to ensure strength and long-lasting durability, capable of withstanding rigorous use.
- 3 Year Warranty, Customer Support and Service in the USA



Adjustable Spreader Beam Description

The Adjustable Spreader Lifting Beam is a heavy-duty lifting solution designed to safely handle loads up to 4000 lbs (2 tons). With a maximum adjustable spread of 120 inches, this beam provides exceptional stability and weight distribution, making it perfect for a wide range of industrial and construction applications.

Technical Specifications

Rated Load Capacity	4000 lbs / 2 tons	Warranty	3 Year
Standards Compliance	ASME B30.20 AND ASME BTH-1		

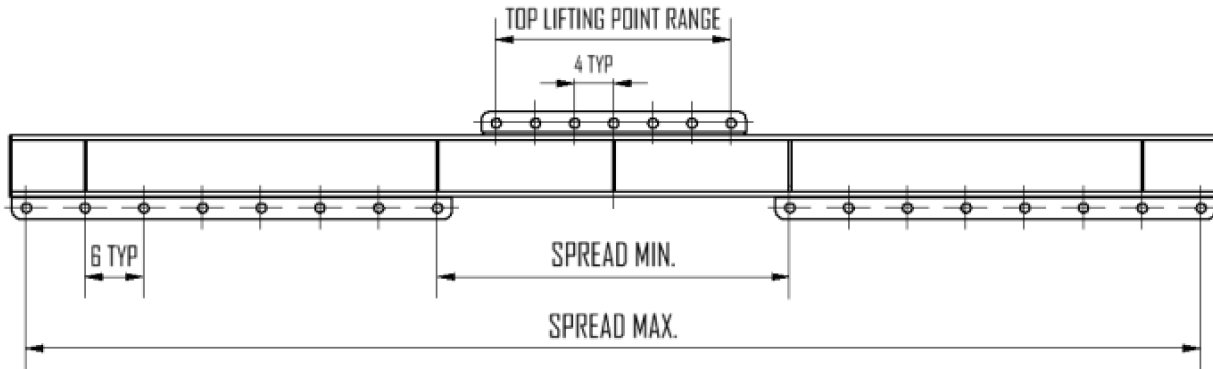
PWYG

MODEL	Cap (lb)	MAX SPREAD (in)	MIN SPREAD (in)	TOP LIFTING POINT RANGE (in)	WEIGHT (lbs)
PWYG1000-48	1000	48	12	16	81
PWYG1000-72	1000	72	36	16	111
PWYG1000-96	1000	96	36	24	151
PWYG1000-120	1000	120	36	24	186
PWYG2000-48	2000	48	12	16	83
PWYG2000-72	2000	72	36	24	116
PWYG2000-96	2000	96	36	24	192
PWYG2000-120	2000	120	36	24	239
PWYG4000-48	4000	48	12	16	105
PWYG4000-72	4000	72	36	24	149
PWYG4000-96	4000	96	36	24	241
PWYG4000-120	4000	120	36	24	364
PWYG8000-72	8000	72	36	32	285
PWYG8000-96	8000	96	36	32	375
PWYG8000-120	8000	120	36	32	537